



Grayhill, Inc.

62S11-L0-020CH

Nambari ya Sehemu:

62S11-L0-020CH

Mtengenezaji / Brand:

Grayhill, Inc.

Maelezo ya bidhaa

ROTARY ENCODER OPTICAL 32PPR

Datasheets:

 62S11-L0-020CH.pdf

Hali ya RoHS

 Kuongoza bure / RoHS Inavyotakiwa

Hali

2105 pcs stock

Meli Kutoka

Hong Kong

Njia ya Uhamisho

DHL/Fedex/TNT/UPS/EMS

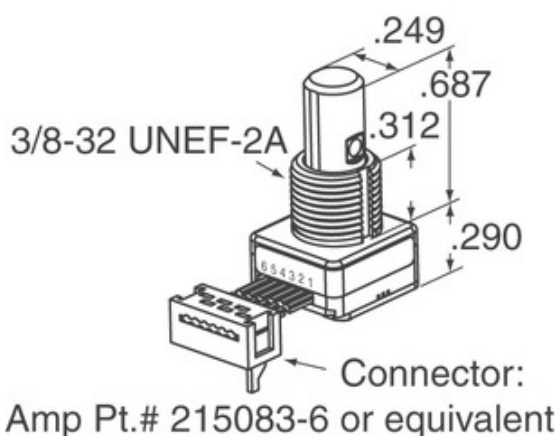

Picha inaweza kuwa uwakilishi. Angalia maelezo ya maelezo ya bidhaa.







Ufafanuzi wa 62S11-L0-020CH

NAMBARI YA SEHEMU	62S11-L0-020CH
MTENGENEZAJI	Grayhill, Inc.
MAELEZO	ROTARY ENCODER OPTICAL 32PPR
HALI YA BURE YA BURE / HALI YA ROHS	Kuongoza bure / RoHS Inavyotakiwa
KIASI INAPATIKANA	2105 pcs
KARATASI YA DATA	 62S11-L0-020CH.pdf
UGAVI WA VOLTAGE	5V
SINEMA YA KUKOMESHA	Cable with Connector
MFULULIZO	62S
MAISHA YA MZUNGUKO (MIZUNGUKO MIN)	1M
PULSES KWA MAPINDUZI	32
AINA YA PATO	Quadrature (Incremental)
MAJINA MENGINE	62S11L0020CH
MWELEKEO	Vertical
AINA YA KUINUA	Panel Mount
KIWANGO CHA SENSITIVITY MOISTURE (MSL)	1 (Unlimited)
HALI YA BURE YA BURE / HALI YA ROHS	Lead free / RoHS Compliant
AINA YA ENCODER	Optical
UZOEFU	Yes
IMEJENGWA KATIKA KUBADILI	No
AINA YA ACTUATOR	1/4" Dia Flatted End

Tags kuhusiana

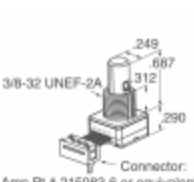
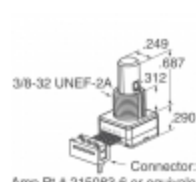
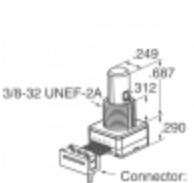
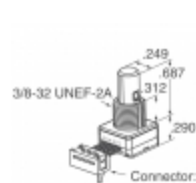
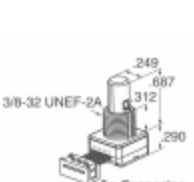
Grayhill, Inc. 62S11-L0-020CH	Mgawanyiko wa 62S11-L0-020CH	Mtoa 62S11-L0-020CH
62S11-L0-020CH Bei	62S11-L0-020CH Picha	62S11-L0-020CH Image
Datasheet ya 62S11-L0-020CH PDF	62S11-L0-020CH Pakua Datasheet	Datasheet ya 62S11-L0-020CH
62S11-L0-020CH Stock	Nunua 62S11-L0-020CH	Nunua Grayhill, Inc. 62S11-L0-020CH
Grayhill, Inc. 62S11-L0-020CH	Mtoa Grayhill, Inc.	Mgawanyiko wa Grayhill, Inc.
Grayhill, Inc. 62S11-L0-020CH	Grayhill Inc. 62S11-L0-020CH	

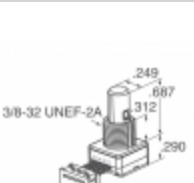
Bidhaa zinazohusiana

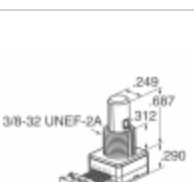
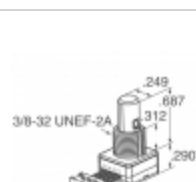
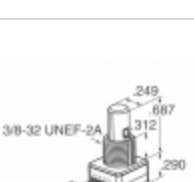
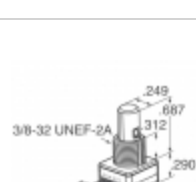
 <p>62S11-H9-P Wazalishaji: Grayhill, Inc. Maelezo: ROTARY ENCODER OPTICAL 32PPR Katika hisa: 2159 pcs</p> <p>RFQ</p>	 <p>62S11-L0-060S Wazalishaji: Grayhill, Inc. Maelezo: ROTARY ENCODER OPTICAL 32PPR Katika hisa: 2241 pcs</p> <p>RFQ</p>
 <p>62S11-H9-PH Wazalishaji: Grayhill, Inc. Maelezo: ROTARY ENCODER OPTICAL 32PPR Katika hisa: 2090 pcs</p> <p>RFQ</p>	 <p>62S11-L0-020C Wazalishaji: Grayhill, Inc. Maelezo: ROTARY ENCODER OPTICAL 32PPR Katika hisa: 1839 pcs</p> <p>RFQ</p>
 <p>62S11-L0-055C Wazalishaji: Grayhill, Inc. Maelezo: ROTARY ENCODER OPTICAL 32PPR Katika hisa: 1995 pcs</p> <p>RFQ</p>	 <p>62S11-L0-040S Wazalishaji: Grayhill, Inc. Maelezo: ROTARY ENCODER OPT 32PPR 4" CBL Katika hisa: 2058 pcs</p> <p>RFQ</p>
 <p>62S11-H9-060SH Wazalishaji: Grayhill, Inc. Maelezo: ROTARY ENCODER OPTICAL 32PPR Katika hisa: 1966 pcs</p> <p>RFQ</p>	 <p>62S11-L0-040C Wazalishaji: Grayhill, Inc. Maelezo: ROTARY ENCODER OPTICAL 32PPR Katika hisa: 2079 pcs</p> <p>RFQ</p>
 <p>62S11-H9-050S Wazalishaji: Grayhill, Inc. Maelezo: ROTARY ENCODER OPTICAL 32PPR Katika hisa: 1839 pcs</p> <p>RFQ</p>	 <p>62S11-H9-060C Wazalishaji: Grayhill, Inc. Maelezo: ROTARY ENCODER OPTICAL 32PPR Katika hisa: 2172 pcs</p> <p>RFQ</p>
 <p>62S11-L0-060SH Wazalishaji: Grayhill, Inc. Maelezo: ROTARY ENCODER OPTICAL 32PPR Katika hisa: 2073 pcs</p> <p>RFQ</p>	 <p>62S11-L0-060CH Wazalishaji: Grayhill, Inc. Maelezo: ROTARY ENCODER OPTICAL 32PPR Katika hisa: 1935 pcs</p> <p>RFQ</p>

Copyright © 2020 Wasambazaji wa Usambazaji wa Vipengele vya Electronic.

E-mail: Info@infinity-electronic.com

Anwani: 17F, Gaylord Commercial Building, 114-118 Lockhart Road, Wan Chai, Hong Kong

